



Fauteuil de gynécologie électrique

**Gamme 725**

**725 01**

**CARINA**  
*Medical*



**CE**  
ISO 9001  
ISO 13485

## DESCRIPTION TECHNIQUE

- Fauteuil de gynécologie à hauteur variable électrique, 3 parties
- Commande : Pédale
- Dossier et jambière réglables par vérins à gaz
- Position de Trendelenburg
- Sellerie tendue plate de bonne densité 35kg/cm<sup>2</sup>, non-feu classée M1, épaisseur 8cm
- Equipé d'un bac inox, d'une paire d'étaux et d'étriers
- Avec porte rouleau pour drap d'examen côté tête
- Piètement acier peint époxy, coloris gris clair (RAL 7035) en standard

## DIMENSIONS

- Largeur 60cm
- Hauteur variable de 62 à 88cm
- Capacité de charge : 130kg

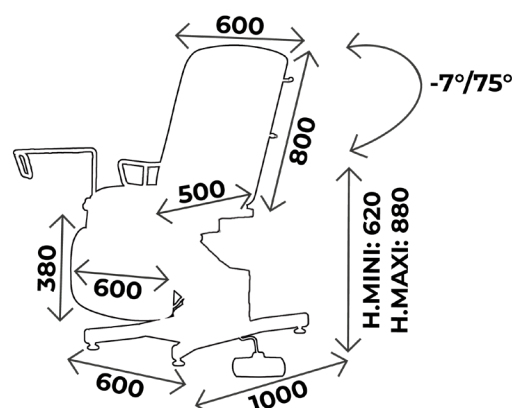

### À SAVOIR

- ✓ Délai : 15 jours à réception commande
- ✓ Garantie : 5 ans (1 an pour la sellerie)

## ACCESSOIRES



**ACC 964**  
Jeu de repose jambes sur rotule en mousse polyuréthane, diam. 14mm, sans étai



**SLFEMIREPOSE**  
Housse prélude pour repose jambes (ACC964), l'unité

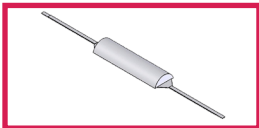

**ACC 54001**  
Têteire 1/2 lune largeur 60cm revêtement non feu M1



**ACC TETERGO**  
Têteire ergonomique amovible

**ACC 514-725-ASS**  
Protection plastique pour assise pour fauteuil 725

**ACC 514-725-JAMB**  
Protection plastique pour jambière pour fauteuil 725



**ACC 725FEMINALED**  
Lampe lumière froide et étai Avec interrupteur sur la tête

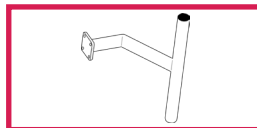

**ACC 63**  
Support colposcope pour 625



**ACC 990**  
Jeu de 4 roulettes à frein diam. 125mm

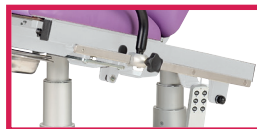

**ACC RAIL IN-L400**  
Paire rails inox 25x10 longueur 40cm



**ACC 537**  
Jeu d'étaux diam. 14mm pour gouttières



**ACC 110**  
Gouttière prise de sang avec ferrure, sans étai, l'unité



**ACC BARRILIT725**  
Paire de barrières de lit escamotables



**ACC 113U-725**  
Gouttière prise de sang avec ferrure, sans étai, l'unité

# COLORIS SELLERIE

Sellerie non-feu  
classée M1

Pour les coloris de sellerie, vous avez le choix entre la gamme Classique et Urban  
Attention ! coloris Urban **avec plus value**

## *Revêtement : Sellerie Gamme Classique*



Arno



Garonne



Potomac

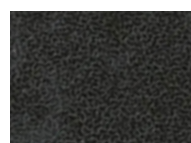

Amour

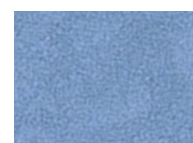

Mississippi



St Laurent



Rhône



Missouri



Seine

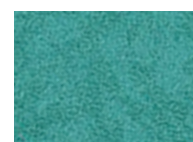

Amazone

## *Revêtement : Sellerie Gamme Urban*



Abysse



Cendre



Origan

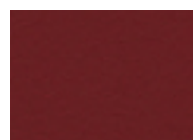

Géranium



Réglisse



Prune

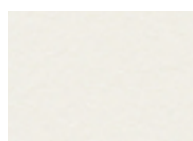

Perle

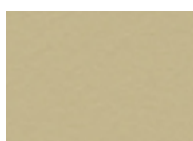

Ficelle

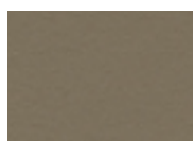

Terre

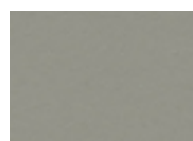

Béton

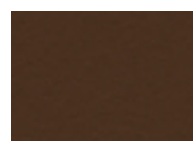

Chataigne

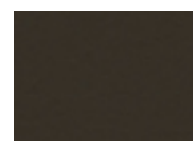

Chocolat



Pensée



Pétrole



Turquoise



Granny



Absinthe



Ananas



Orange



Fuschia



Tomate

# COLORIS PIÈTEMENT

Le fauteuil 725 01 est proposé en coloris (RAL 7035) en standard  
Possibilité de changer le coloris de piètement **sans plus value**

## *Piètement Peinture EPOXY*



RAL 9003

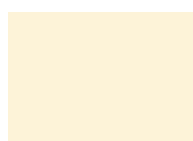

RAL 1013

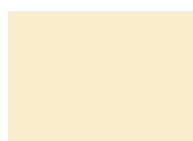

RAL 1015



RAL 6019



RAL 6033



RAL 6000



RAL 5017



RAL 5002



RAL 5000



RAL 7035



RAL 7016



RAL 9005



RAL 1018



RAL 3020



RAL 3003

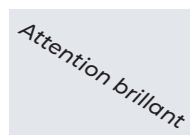

ARGENT



## GUIDE D'ENTRETIEN

### ENTRETIEN QUOTIDIEN

- Sellerie : nettoyage à l'eau savonneuse uniquement (solvants proscrits), peut être désinfecté avec des produits tels que Phagosept Spray, Salvanios pH10 à 0,75% et Anios Surfaces Hautes, sans matière abrasive
- Piètement : nettoyage à l'eau savonneuse uniquement (solvants proscrits) sans matière abrasive

### GARANTIE

- Châssis : 5 ans
- Sellerie : 1 an



**CONTACT**

**CARINA**  
*Médical*

Parc d'entreprises Visionis  
278 rue de l'industrie  
01090 GUÉREINS- FRANCE

**SERVICE COMMERCIAL**

Tél: +33(0)4 74 66 69 49  
Fax: +33(0)4 74 66 69 50  
[commercial@carinamedical.com](mailto:commercial@carinamedical.com)