



Fauteuil de gynécologie fixe

Gamme 524

526

CARINA
Medical



CE
ISO 9001
ISO 13485

DESCRIPTION TECHNIQUE

- Fauteuil de gynécologie à hauteur fixe, 3 parties
- Dossier réglable par vérin à gaz
- Avec jambièrre réglable par système mécanique, assise inclinable mécaniquement (2 positions : 0/+4cm)
- Réglage de la jambièrre en 2 positions : horizontale dans l'alignement de l'assise ou verticale
- Position de Trendelenburg
- Sellerie plate de bonne densité 30kg/cm², avec coutures apparentes, non-feu classée M1, épaisseur 8cm
- Equipé d'un bac inox, d'une paire d'étaux et d'étriers
- Avec porte rouleau pour drap d'examen côté tête
- Piètement acier peint époxy, coloris gris clair (RAL 7035) en standard

DIMENSIONS

- Largeur 60cm
- Hauteur 83cm
- Capacité de charge : 150kg

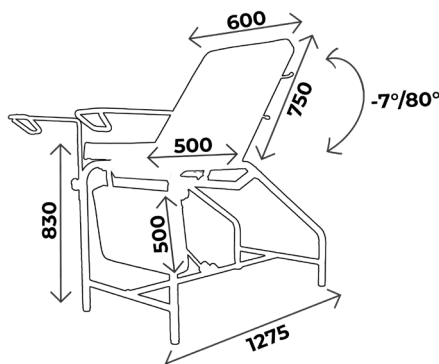

Vous aimerez aussi :

Réf. **524** : Idem 526 avec assise fixe

V01-10/21



À SAVOIR

- ✓ Délai : 15 jours à réception commande
- ✓ Garantie : 5 ans (1 an pour la sellerie)

ACCESSOIRES



ACC 964
Jeu de repose jambes sur rotule en mousse polyuréthane, diam. 14mm, sans étai



SLFEMIREPOSE
Housse prélude pour repose jambes (ACC964), l'unité



ACC TETERGO
Tête ergonomique amovible

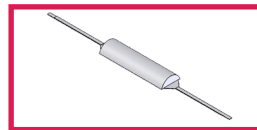

ACC 54001
Tête 1/2 lune largeur 60cm revêtement non feu M1

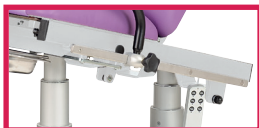

ACC RAIL IN-L400
Paire rails inox 25x10 longueur 40cm



ACC 537
Jeu d'étaux diam. 14mm pour gouttières



ACC 75
Jeu d'étaux diam. 14mm



ACC 110
Gouttière prise de sang avec ferrure, sans étai, l'unité

COLORIS SELLERIE

Sellerie non-feu
classée M1

Pour les coloris de sellerie, vous avez le choix entre la gamme Classique et Urban
Attention ! coloris Urban **avec plus value**

Revêtement : Sellerie Gamme Classique

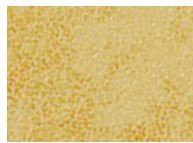

Arno



Garonne



Potomac

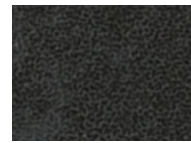

Amour

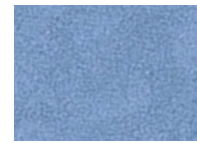

Mississippi

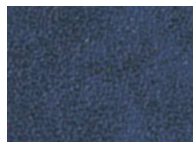

St Laurent

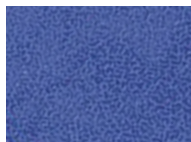

Rhône

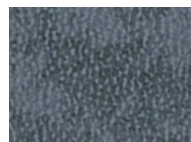

Missouri



Seine



Amazone

Revêtement : Sellerie Gamme Urban



Abysse



Cendre



Origan



Géranium



Réglisse



Prune

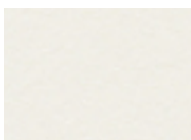

Perle

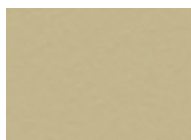

Ficelle



Terre



Béton

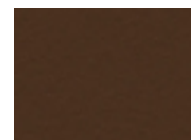

Chataigne

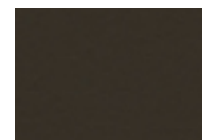

Chocolat

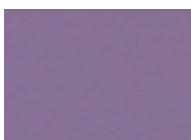

Pensée



Pétrole



Turquoise



Granny



Absinthe



Ananas



Orange



Fuschia



Tomate

COLORIS PIÈTEMENT

Le fauteuil 526 est proposé en coloris (RAL 7035) en standard
Possibilité de changer le coloris de piètement **sans plus value**

Piètement Peinture EPOXY



RAL 9003

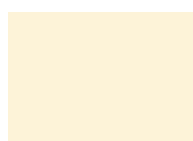

RAL 1013

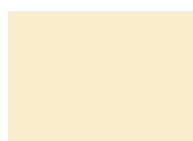

RAL 1015



RAL 6019



RAL 6033



RAL 6000



RAL 5017



RAL 5002



RAL 5000



RAL 7035



RAL 7016



RAL 9005



RAL 1018



RAL 3020



RAL 3003

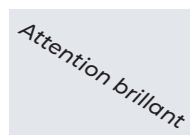

ARGENT



GUIDE D'ENTRETIEN

ENTRETIEN QUOTIDIEN

- Sellerie : nettoyage à l'eau savonneuse uniquement (solvants proscrits), peut être désinfecté avec des produits tels que Phagosept Spray, Salvanios pH10 à 0,75% et Anios Surfaces Hautes, sans matière abrasive
- Piètement : nettoyage à l'eau savonneuse uniquement (solvants proscrits) sans matière abrasive

GARANTIE

- Châssis : 5 ans
- Sellerie : 1 an



CONTACT

CARINA
Médical

Parc d'entreprises Visionis
278 rue de l'industrie
01090 GUÉREINS- FRANCE

SERVICE COMMERCIAL

Tél: +33(0)4 74 66 69 49
Fax: +33(0)4 74 66 69 50
commercial@carinamedical.com